

# Series 1000 brass universal nose fittings

Nose fittings for plastic, copper and brass tubes:  $\varnothing$  4, 6, 8, 10, 12 mm  
Fittings threads: BSP (G1/8, G1/4), BSPT (R1/8, R1/4, R3/8, R1/2)

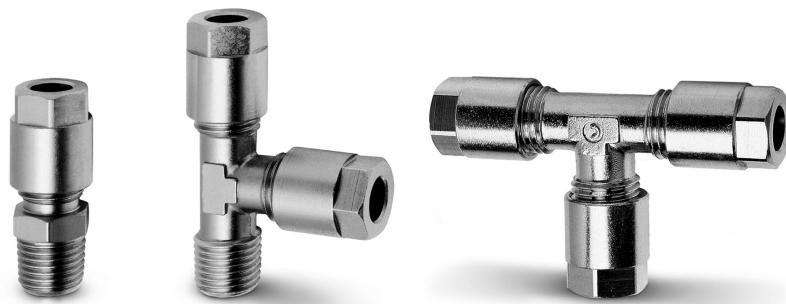

Series 1000 nose fittings are used with plastic tubes as well as with copper, brass, steel and aluminium tubes. These fittings, which are suitable for several applications, can be used within pneumatic, oil-pressure and low-pressure hydraulic circuits.

The fittings seats, noses and nuts comply with the DIN 3870-3861 standards.

## GENERAL DATA

<b>Diameters</b>	$\varnothing$ 4 - 6 - 8 - 10 - 12 mm
<b>Threads</b>	GAS, conical ISO 7 (BSPT) GAS, cylindrical ISO 228 (BSP)
<b>Temperature</b>	see data for tubing used
<b>Connecting tube</b>	annealed copper and plastic tubes (with reinforcement)
<b>Medium</b>	compressed air and other low pressure fluids
<b>Materials</b>	nickel-plated brass
<b>Working pressure</b>	max 40 bar

## Fittings with connecting tube

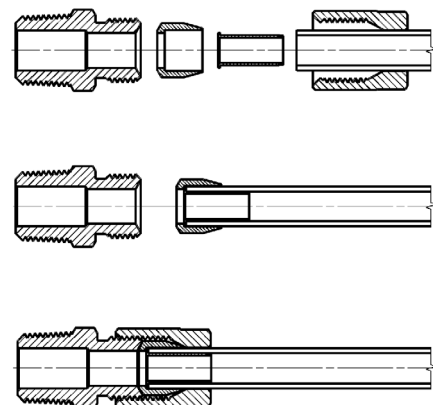

**Fittings Mod. 1050**



BSPT Male Connector

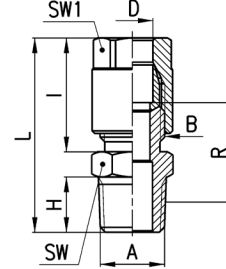

DIMENSIONS											
Mod.	D	A	B	H	I	L	R	SW	SW1	Weight (g)	
1050 4-1/8	4	R1/8	1/8	7,5	19	31	14	12	12	19	
1050 6-1/8	6	R1/8	1/8	7,5	19	31	14	12	12	18	
1050 6-1/4	6	R1/4	1/8	11	19	35	16,5	14	12	23	
1050 8-1/8	8	R1/8	1/4	7,5	23	35	15,5	14	14	29	
1050 8-1/4	8	R1/4	1/4	11	23	39	18	14	14	33	
1050 8-3/8	8	R3/8	1/4	11,5	23	39,5	18	17	14	40	
1050 10-1/4	10	R1/4	3/8	11	25,5	41,5	18	17	17	51	
1050 10-3/8	10	R3/8	3/8	11,5	25,5	42	18	17	17	55	
1050 10-1/2	10	R1/2	3/8	14	25,5	45	18	22	17	65	
1050 12-1/4	12	R1/4	M18x1,5	11	24,5	40,5	12	19	19	56	*
1050 12-3/8	12	R3/8	M18x1,5	11,5	24,5	41	12	19	19	58	*
1050 12-1/2	12	R1/2	M18x1,5	14	24,5	44	12	22	19	68	*

\* = with bi-conical olive

**Fittings Mod. 1063**

BSP Female Connector

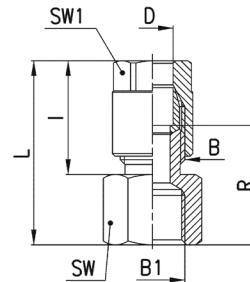

DIMENSIONS									
Mod.	D	B1	B	I	L	R	SW	SW1	Weight (g)
1063 4-1/8	4	G1/8	1/8	19	29	18,5	13	12	19
1063 6-1/8	6	G1/8	1/8	19	29	18,5	13	12	18
1063 6-1/4	6	G1/4	1/8	19	30,5	20	17	12	25
1063 8-1/8	8	G1/8	1/4	23	33	20	14	14	31
1063 8-1/4	8	G1/4	1/4	23	34,5	21,5	17	14	35

## Fittings Mod. 1020

BSPT Fix Male Elbow

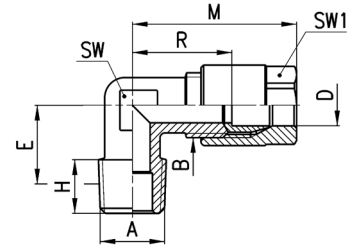

DIMENSIONS											
Mod.	D	A	B	E	H	M	R	SW	SW1	Weight (g)	
1020 4-1/8	4	R1/8	1/8	11,5	7,5	29,5	19	9	12	21	
1020 6-1/8	6	R1/8	1/8	11,5	7,5	29,5	19	9	12	19	
1020 6-1/4	6	R1/4	1/8	13,5	11	29,5	19	12	12	27	
1020 8-1/8	8	R1/8	1/4	11,5	7,5	33	20	11	14	35	
1020 8-1/4	8	R1/4	1/4	13,5	11	33	20	12	14	36	
1020 8-3/8	8	R3/8	1/4	15,5	11,5	35	22	14	14	50	
1020 10-1/4	10	R1/4	3/8	15	11	38	22,5	13	17	59	
1020 10-3/8	10	R3/8	3/8	15,5	11,5	38	22,5	14	17	58	
1020 10-1/2	10	R1/2	3/8	16	14	38	22,5	16	17	78	
1020 12-1/4	12	R1/4	M18x1,5	15	11	37	16,5	15	19	66	*
1020 12-3/8	12	R3/8	M18x1,5	15	11,5	37	16,5	15	19	66	*
1020 12-1/2	12	R1/2	M18x1,5	16	14	37	16,5	16	19	75	*

\* = with bi-conical olive

## Fittings Mod. 1093

BSP Female Elbow

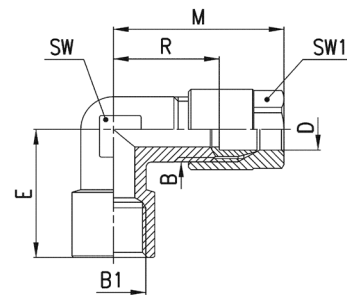

DIMENSIONS										
Mod.	D	B1	B	E	M	R	SW	SW1	Weight (g)	
1093 4-1/8	4	G1/8	1/8	19	29,5	18,5	12	12	31	
1093 6-1/8	6	G1/8	1/8	19	29,5	19	12	12	25	
1093 6-1/4	6	G1/4	1/8	23	30,5	20	13	12	39	
1093 8-1/8	8	G1/8	1/4	19	33	20	11	14	39	
1093 8-1/4	8	G1/4	1/4	23	35	22	13	14	44	

### Fittings Mod. 1000

BSPT Fix Male Tee

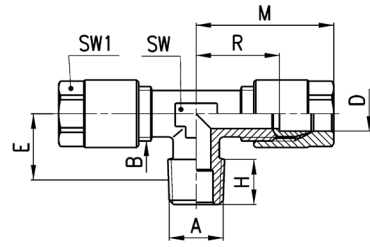

DIMENSIONS										
Mod.	D	A	B	E	H	M	R	SW	SW1	Weight (g)
1000 4-1/8	4	R1/8	1/8	11,5	7,5	29,5	19	9	12	35
1000 6-1/8	6	R1/8	1/8	11,5	7,5	29,5	19	9	12	33
1000 8-1/4	8	R1/4	1/4	13,5	11	33	20	12	14	63
1000 10-1/4	10	R1/4	3/8	15	11	38	22,5	13	17	104

### Fittings Mod. 1010

Lateral BSPT Fix Male Tee

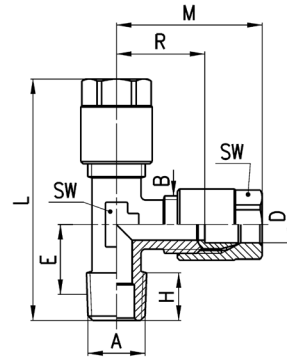

DIMENSIONS											
Mod.	D	A	B	E	H	L	M	R	SW	SW1	Weight (g)
1010 4-1/8	4	R1/8	1/8	11,5	7,5	48	29,5	19	9	12	37
1010 6-1/8	6	R1/8	1/8	11,5	7,5	48	29,5	19	9	12	33
1010 8-1/4	8	R1/4	1/4	13,5	11	54,5	33	20	12	14	61
1010 10-1/4	10	R1/4	3/8	15	11	61,5	38	22,5	13	17	103

### Fittings Mod. 1230

Union Connector

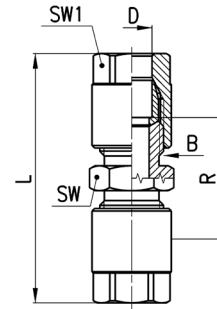

DIMENSIONS							
Mod.	D	B	L	R	SW	SW1	Weight (g)
1230 4	4	1/8	42,5	21,5	12	12	29
1230 6	6	1/8	42,5	21,5	12	12	26
1230 8	8	1/4	51	25	14	14	48
1230 10	10	3/8	56	25	17	17	83
1230 12	12	M18x1,5	54	13	19	19	140

\* = with bi-conical olive

### Fittings Mod. 1250

Bulkhead Connector

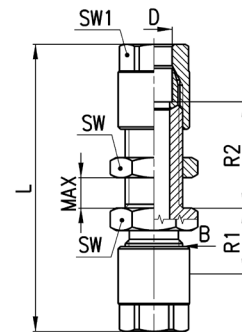

DIMENSIONS									
Mod.	D	B	L	R1	R2	MAX	SW	SW1	Weight (g)
1250 4	4	1/8	57,5	12,5	23	12	14	12	40
1250 6	6	1/8	57,5	13	23,5	12	14	12	38
1250 8	8	1/4	65	15	24	13	17	14	67
1250 10	10	3/8	72,5	15	26,5	13	22	17	119

### Fittings Mod. 1220

Elbow Connector

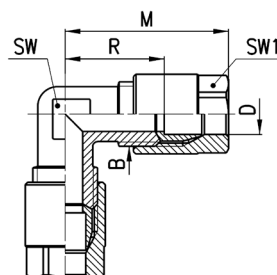

DIMENSIONS							
Mod.	D	B	M	R	SW	SW1	Weight (g)
1220 4	4	1/8	29,5	19	9	12	31
1220 6	6	1/8	29,5	19	9	12	29
1220 8	8	1/4	33	20	11	14	53
1220 10	10	3/8	38	22,5	14	17	92
1220 12	12	M18x1,5	37	16,5	16	19	99 *

\* = with bi-conical olive

### Fittings Mod. 1210

Tee Connector

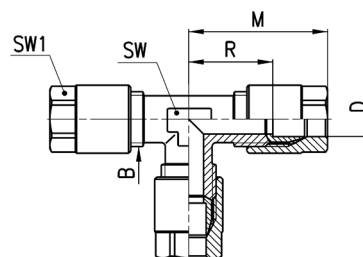

DIMENSIONS							
Mod.	D	B	M	R	SW	SW1	Weight (g)
1210 4	4	1/8	29,5	19	9	12	45
1210 6	6	1/8	29,5	19	9	12	42
1210 8	8	1/4	33	20	12	14	79
1210 10	10	3/8	38	22,5	13	17	133
1210 12	12	M18x1,5	37	16,5	16	19	144 *

\* = with bi-conical olive

### Fittings Mod. 1170

Single Banjo

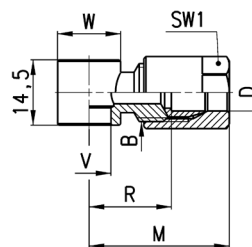

DIMENSIONS										
Mod.	D	B	R	M	V	W	SW1	Weight (g)	assembled with Mod.	
1170 6-1/8	6	1/8	17.5	28	9.8	14	12	20	1631, 1635, SCU, SVU, SCO...	
1170 6-1/4	6	1/8	20	30.5	13.2	18	12	24	1631, 1635, SCU, SVU, SCO...	
1170 8-1/8	8	1/4	18	31	9.8	14	14	31	1635, SCU, SVU, SCO...	

### Accessories Mod. 1303

Blocking nut

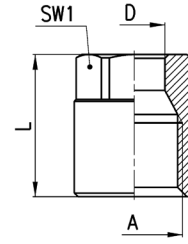

DIMENSIONS					
Mod.	D	A	L	SW1	Weight (g)
1303 4-1/8	4	1/8	15,5	12	8
1303 6-1/8	6	1/8	15,5	12	8
1303 8-1/4	8	1/4	19	14	14
1303 10-3/8	10	3/8	21,5	17	24
1303 12-M18x1,5	12	M18x1,5	19,5	19	27

### Accessories Mod. 1310

Olive and Bicone

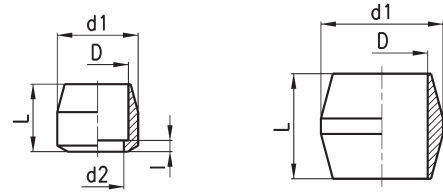

FIG. 1

FIG. 2

DIMENSIONS						
Mod.	D	d1	d2	l	L	Weight (g)
1310 4	4	7,8	3	1	8	2
1310 6	6	7,8	4,5	1	7	1
1310 8	8	10,8	7	1,5	9	3
1310 10	10	13,8	9	1,5	11,5	5
1310 12-M18	12	16,3	12	-	11	6 *

Fig. 1 = olive

Fig. 2 = bi-conical olive

\* = with bi-conical olive

### Accessories Mod. 1320

Inserts

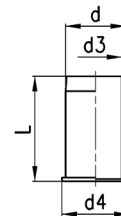

DIMENSIONS					
Mod.	d	d3	d4	L	Weight (g)
1320 4	4	3	5	12	1
1320 6	6	5	7	13	1
1320 8	8	7	9	14	1
1320 10	10	9	11	16	2